

January 10, 2024

**Reference:** CSIO/MSSA/HCP0031/063

**Subject:** Call for Expression of Interest (EoI)/quotation for the purchase of goods/fabrication job work for the ongoing project activities- reg

It is informed that following items are proposed to be purchased /fabricated. Interested parties are requested to **submit quotation** through email/hard copy to the undersigned **within next three days** from the date of publishing of notice.

**Items/Goods/Job work required**

Sr. No.	Description of the items/Goods/Jobwork	Quantity
1.	PCB Fabrication and Component Assembly as per the Annexure- I	20 nos

**Terms and Conditions:**

Delivery: For CSIR-CSIO, Chandigarh

Lead time/delivery time: 4-6 weeks

Payment: After delivery and successful inspection



**Dr Babankumar S. Bansod**  
**Senior Principal Scientist & Project Leader**  
**9888520252; scientist\_babankumar@csio.res.in**

**HEAD ISD**, with a request to display on the CSIO website

# Annexure-I

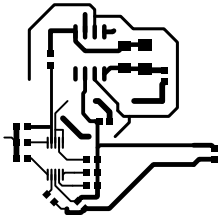

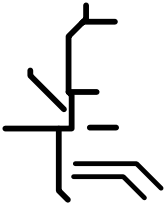

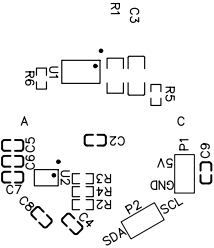

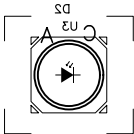

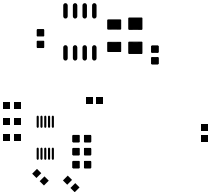



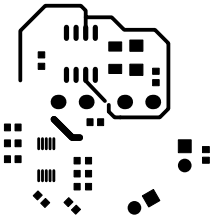



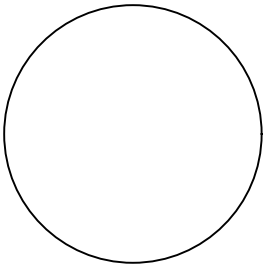

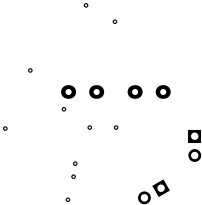

mm080.2

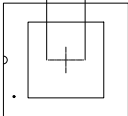



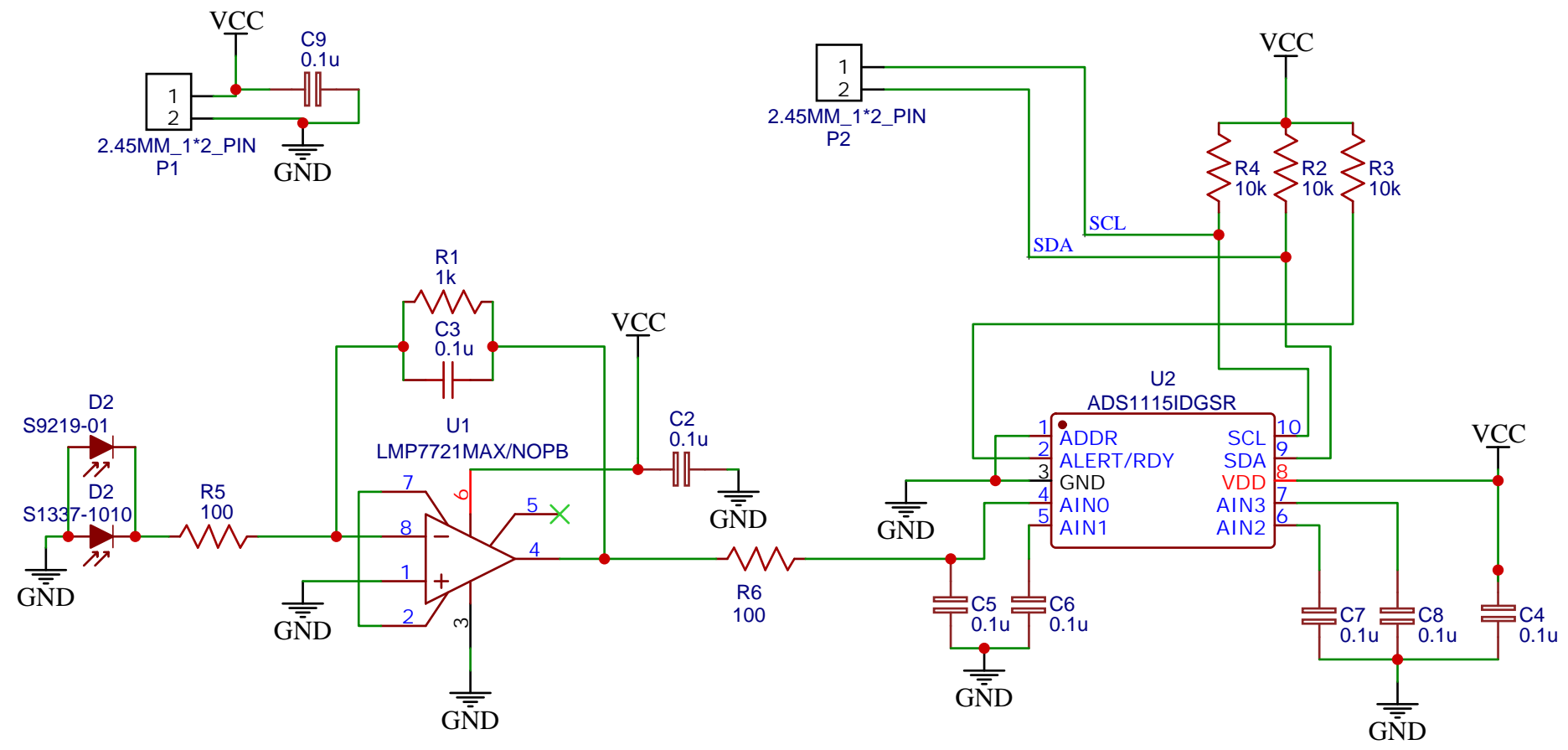

TITLE	Project 1	REV.	1.0
Author	Company	Sheet.	1/1
Date	Drawn By		